



Design and Manufacture Data Booklet

National 5, Higher and Advanced Higher

This edition: May 2024, version 1.3

Published by the Scottish Qualifications Authority
The Optima Building, 58 Robertson Street, Glasgow G2 8DQ
Lowden, 24 Wester Shawfair, Dalkeith, Midlothian EH22 1FD

www.sqa.org.uk

© Scottish Qualifications Authority 2024

Contents

Anthropometric data

- Standing and seated figures 4
- Hand and head 5
- Wheelchair 5

Production costs

- Manufacturing processes 6
- Fabrication costs 7
- Assembly costs 7

Stock material sizes and costs

- Dressed timber, man-made boards and dowelling 8
- Metal sections and sheets 9
- Plastic sections, granules and sheets 10

Fixings

- Threaded bar, nuts, bolts and washers 12
- Screws 12
- Pop rivets 12

Anthropometric data

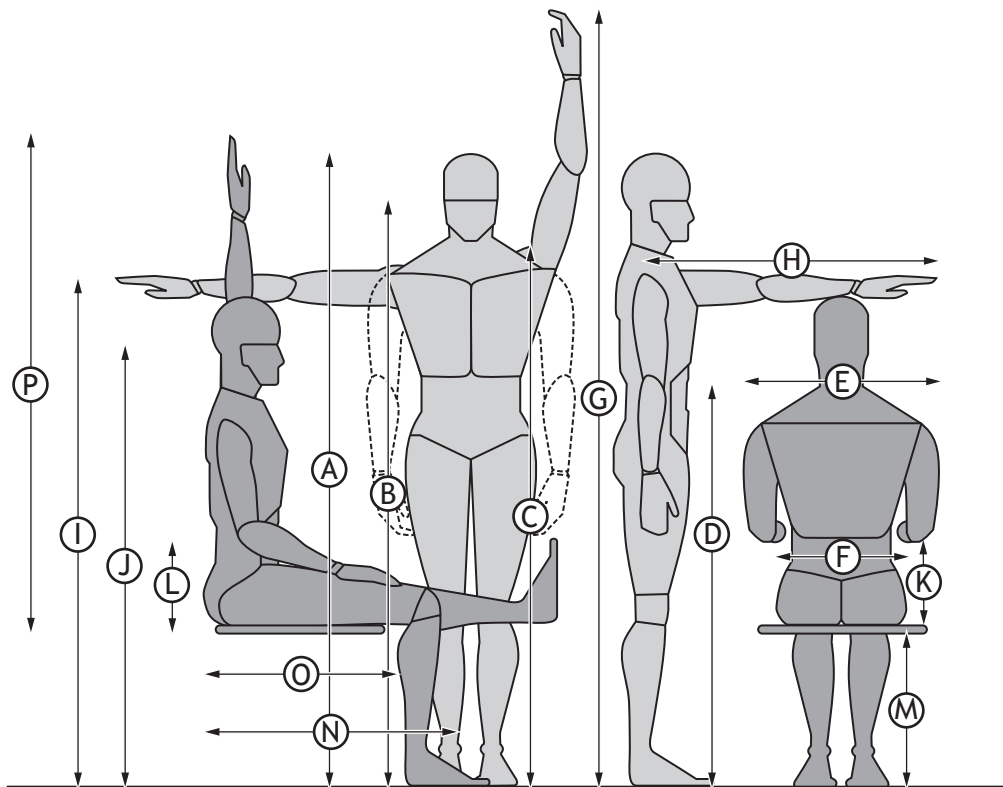

Standing and seated figures		Adult male			Adult female			4-year-old child			16-year-old boy			16-year-old girl		
		Percentile			Percentile			Percentile			Percentile			Percentile		
		5 th	50 th	95 th	5 th	50 th	95 th	5 th	50 th	95 th	5 th	50 th	95 th	5 th	50 th	95 th
A	Height	1642	1756	1870	1515	1621	1827	974	1053	1133	1609	1735	1861	1484	1601	1818
B	Eye level	1528	1641	1754	1410	1516	1616	872	951	1030	N/A	N/A	N/A	N/A	N/A	N/A
C	Shoulder height	1345	1451	1556	1231	1330	1429	749	828	906	1240	1439	1555	1135	1319	1428
D	Elbow height	1021	1107	1192	948	1021	1094	552	607	662	N/A	N/A	N/A	N/A	N/A	N/A
E	Shoulder width	443	484	537	390	452	523	234	257	287	397	441	498	382	417	478
F	Hip width	315	354	403	330	371	442	175	192	209	283	319	356	290	327	364
G	Vertical reach	2065	2231	2398	1898	2205	2051	1094	1211	1328	1854	2108	2279	1854	1954	1949
H	Forward reach	760	820	879	671	738	804	389	450	505	707	842	860	626	695	764
I	Sitting height	821	920	979	800	855	870	532	580	587	801	898	972	780	834	863
J	Eye level (seated)	706	805	863	689	743	758	435	482	490	723	821	858	N/A	N/A	N/A
K	Elbow height (seated)	206	241	276	197	230	264	122	138	150	185	236	248	145	230	237
L	Thigh clearance	129	162	207	139	164	209	N/A	N/A	N/A	N/A	N/A	N/A	N/A	N/A	N/A
M	Popliteal height	410	455	499	370	412	455	227	261	295	370	448	488	370	409	448
N	Buttock-front knee length	567	619	677	541	592	655	303	339	379	N/A	N/A	N/A	N/A	N/A	N/A
O	Buttock-popliteal length	456	503	556	438	484	540	238	274	313	N/A	N/A	N/A	N/A	N/A	N/A
P	Sitting reach	1220	1305	1390	1100	1190	1280	694	764	818	1114	1074	1343	1032	1145	1257

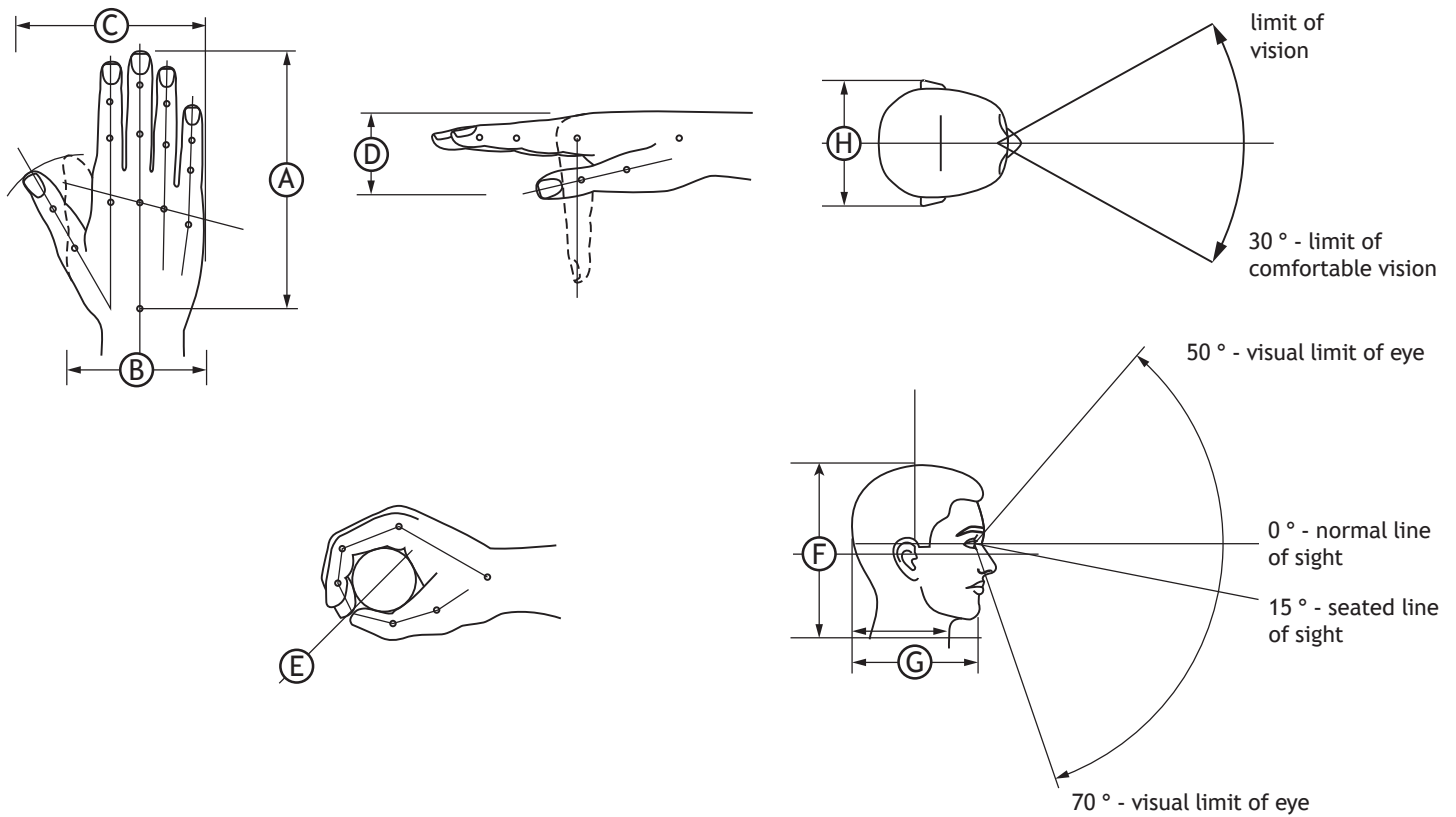

Hand and head		Adult male			Adult female			4-year-old child			16-year-old boy			16-year-old girl		
		Percentile			Percentile			Percentile			Percentile			Percentile		
		5 th	50 th	95 th	5 th	50 th	95 th	5 th	50 th	95 th	5 th	50 th	95 th	5 th	50 th	95 th
A	Hand length	170	190	210	160	175	190	106	116	127	N/A	N/A	N/A	N/A	N/A	N/A
B	Hand breadth	80	90	100	70	80	90	49	55	61	N/A	N/A	N/A	N/A	N/A	N/A
C	Hand span	97	107	116	83	92	101	58	66	73	N/A	N/A	N/A	N/A	N/A	N/A
D	Hand thickness	26	30	34	22	26	30	15	18	21	N/A	N/A	N/A	N/A	N/A	N/A
E	Grip diameter INDEX finger	35	47	55	33	38	44	21	28	33	N/A	N/A	N/A	N/A	N/A	N/A
F	Head height	201	217	232	188	201	214	165	181	198	201	219	237	191	207	223
G	Head length	185	198	210	172	184	196	164	176	188	170	182	193	174	187	200
H	Head breadth	135	144	153	122	131	141	100	109	117	N/A	N/A	N/A	N/A	N/A	N/A

Wheelchair			
		Adult	Child
A	Height	914	914
B	Length	1220	890
C	Breadth	760	670
D	Seat height	495	360
E	Arm rest height	737	N/A

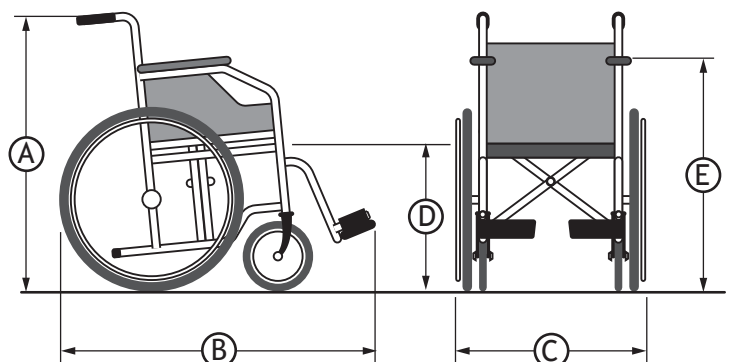

Production costs

Manufacturing processes

The information in the following tables provides estimated costs for the commercial production of component parts. Assumptions on volume of production and economies of scale have been made to allow for comparisons between each process.

Costs are for production only and do not include cost of materials, secondary processes or transportation.

- Small parts are less than or equal to 50 mm x 50 mm x 50 mm
- Medium parts are less than or equal to 150 mm x 150 mm x 150 mm
- Large parts are less than or equal to 300 mm x 300 mm x 300 mm

	Simple			Medium			Complex		
	<ul style="list-style-type: none"> • Simple solid form or basic shell structure • Little surface detail or texture • No ribs, webs or bosses • Uniform wall thickness 			<ul style="list-style-type: none"> • Complex solid form or shell structure • Surface detail and texture • Few manufacturing features: ribs, webs and bosses 			<ul style="list-style-type: none"> • Highly complex shell structures • High levels of surface detail • Several manufacturing features: ribs, webs and bosses • Integrated assembly features 		
	small	medium	large	small	medium	large	small	medium	large
Injection moulding	£1.85	£5.00	£16.00	£2.25	£6.60	£22.50	£3.75	£10.00	£33.30
Die casting	£1.85	£5.00	£16.00	£2.20	£5.80	£19.60	£3.25	£8.30	£28.30
Compression moulding	£0.90	£2.50	£8.30	£1.10	£2.90	£9.80	£1.60	£4.20	£14.20
Sand casting	£1.25	£2.00	£5.60	£1.90	£5.00	£16.60			

	Simple			Medium			Complex		
	<ul style="list-style-type: none"> • Simple geometric forms • Little surface detail or texture • Uniform wall thickness 			<ul style="list-style-type: none"> • Complex geometric forms • Good level of surface detail 			<ul style="list-style-type: none"> • Highly complex forms • High levels of surface detail 		
	small	medium	large	small	medium	large	small	medium	large
Rotational moulding	£0.30	£0.85	£2.80	£0.90	£2.50	£8.30	£1.60	£4.20	£14.00
Vacuum forming	£0.30	£0.85	£2.80	£0.65	£1.60	£5.60	£1.25	£3.30	£11.25

	Simple			Medium			Complex		
	<ul style="list-style-type: none"> • Simple line bends • Thin sheet 			<ul style="list-style-type: none"> • Complex line bends • Simple geometric forms • Large radii corners 			<ul style="list-style-type: none"> • Highly complex line bends • Complex geometric forms • Small radii corners • Deep drawing 		
	small	medium	large	small	medium	large	small	medium	large
Press forming	£0.62	£1.60	£5.60	£1.25	£3.30	£11.25	£1.87	£5.00	£16.60

The information in the following table provides estimated costs for extrusion.

Costs are for production only and do not include cost of materials, secondary processes or transportation.

- Small parts are less than or equal to 10 mm x 10 mm
- Medium parts are less than or equal to 50 mm x 50 mm
- Large parts are less than or equal to 100 mm x 100 mm
(price per linear metre)

	Simple			Medium			Complex		
	<ul style="list-style-type: none"> • Simple geometric forms • Open profile L H T sections 			<ul style="list-style-type: none"> • Complex geometric forms • Closed profile 			<ul style="list-style-type: none"> • Highly complex geometric forms 		
	small	medium	large	small	medium	large	small	medium	large
Extrusion	£2·60	£3·00	£3·50	£3·00	£3·50	£4·50	£3·40	£4·00	£5·00

Fabrication costs

Machining			
	Wood	Metal	Plastic
Lathe work	£0·15 per feature/process	£0·20 per feature/process	£0·20 per feature/process
Milling		£0·20 per feature/process	£0·20 per feature/process
Drilling	£0·25 per hole	£0·40 per hole	£0·25 per hole

Cutting and forming			
	Wood	Metal	Plastic
Bending	£0·50 per bend	£0·25 per bend	£0·20 per bend
Cutting	£0·20 per cut	£0·20 per cut	£0·20 per cut

Finishing (price per 1000 mm²)			
	Wood	Metal	Plastic
Chrome plating		£0·15	£0·15
Galvanising		£0·15	
Dip coating		£0·15	
Painting	£0·10	£0·10	£0·10
Powder coating		£0·15	
Polishing		£0·05	£0·05

Assembly costs

	Wood	Metal	Plastic
Assembling using snap fits		£0·05 per part	£0·05 per part
Assembling using screws, nuts and bolts	£0·15 per part	£0·15 per part	£0·15 per part
Assembling using glue	£0·10 per part	£0·10 per part	£0·10 per part
Welding		£0·50 per join	
Riveting	£0·10 per rivet	£0·10 per rivet	£0·10 per rivet

Stock material sizes and costs

(*all sizes given in mm)









Dressed timber, man-made boards and dowelling

Dressed timber (price per linear metre)					
Size	Pine	Ash	Beech	Mahogany	Oak
25 × 25	£0.50	£1.93	£1.52	£2.05	£2.37
50 × 25	£0.93	£4.80	£2.75	£3.68	£4.27
50 × 50	£1.75	£8.67	£5.71	£7.38	£10.49
75 × 25	£1.30	£5.02	£3.98	£5.34	£6.18
75 × 50	£2.85	£12.55	£8.26	£10.69	£15.17
75 × 75	£3.25	£16.38	£11.97	£17.08	£44.88
100 × 25	£1.86	£6.56	£5.22	£7.00	£12.08
100 × 50	£3.71	£16.42	£10.82	£13.20	£19.85
100 × 100	£6.80			£21.08	£54.80
150 × 25	£2.60	£9.65	£7.68	£10.29	£18.12
150 × 50	£5.46	£24.15	£15.91	£20.58	£30.30
175 × 25	£3.22	£11.20	£8.91	£11.94	£14.27
175 × 50	£6.51	£28.02	£18.46	£23.88	£35.16
200 × 25	£3.68	£12.38	£10.14	£13.58	£20.68
225 × 25	£4.14		£11.32	£15.25	£23.08

Man-made boards (price per 1220 mm × 2440 mm sheet)					
Size	MDF	Flexi ply	Plywood	Hardboard	Chipboard
3		£29.98		£5.95	
5		£34.98			
6	£14.49		£15.86		
8		£39.98			
9	£21.74		£19.04		
12	£23.00		£26.99		£11.48
15					
18	£26.63		£38.90		£17.36
25	£36.99				





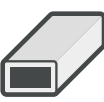

Dowelling (price per linear metre)					
Size	Ash	Beech	Mahogany	Oak	Pine
Ø 6	£0.94	£0.94	£1.62	£0.90	
Ø 9	£1.43	£1.45	£2.22	£1.51	
Ø 12			£2.94	£2.34	£2.08
Ø 15	£2.94	£2.22	£3.59	£3.13	£2.88
Ø 18	£3.16	£2.65	£4.25	£3.48	£3.06
Ø 25	£4.19	£3.46	£5.82	£4.14	£3.96
Ø 35	£8.16	£7.51	£10.26	£8.10	£6.66
Ø 45	£15.32	£14.64	£14.04	£16.04	

Metal sections and sheets

Metal sections (price per linear metre)					
	Size	Mild steel	Aluminium	Stainless steel	Brass
Round bar 	Ø 10	£2.15	£4.40	£9.10	£17.10
	Ø 20	£7.03	£9.23	£18.79	£30.66
	Ø 30	£14.67	£17.06	£42.23	£84.40
	Ø 40	£26.09	£28.84	£75.02	£169.70
	Ø 50	£40.75	£43.67	£117.17	£225.90
Flat bar 	3 × 20	£2.96	£1.84	£7.72	£17.10
	3 × 30	£3.54	£3.37	£9.72	£23.28
	5 × 40	£7.13	£7.54	£15.53	£37.93
	5 × 50	£8.90	£9.10	£13.87	£39.97
Square bar 	10 × 10	£3.36	£4.21	£12.35	£16.73
	20 × 20	£13.37	£11.75	£33.17	£44.65
	30 × 30	£30.10	£21.71	£57.32	£118.40
	40 × 40	£53.66	£31.27		£137.40
	50 × 50		£55.62		£275.35
T section 	20 × 20 × 1.6		£4.84		
	25 × 25 × 3		£5.30	£29.18	£54.63
	40 × 40 × 5		£9.14		£84.43
	50 × 50 × 6	£36.99	£13.03		
U Section 	25 × 25 × 3	£11.16	£7.19	£29.31	£69.20
	40 × 20 × 3		£9.95	£42.05	
	50 × 25 × 3		£12.03	£47.37	
	70 × 40 × 5	£33.49	£24.00		
	100 × 50 × 6	£18.14	£44.00	£134.58	
I section 	76 × 35	£33.49			
	127 × 76	£32.10			
	203 × 102	£57.43			
	254 × 254	£76.55			
Angle bar 	25 × 25 × 3	£4.40	£4.87	£14.97	£27.25
	30 × 30 × 3	£5.95	£6.23	£20.36	£49.98
	40 × 40 × 5	£7.34	£11.00	£27.77	£59.66
	50 × 50 × 5	£14.96	£22.16	£52.53	
Square section 	15 × 15 × 2	£2.84	£5.95	£14.89	£27.04
	20 × 20 × 2	£2.96	£10.63	£22.21	£35.40
	30 × 30 × 3	£6.62	£11.99	£17.18	£62.76
	50 × 50 × 3	£11.61	£20.00	£37.52	£95.15
Round tube 	Ø 15 × 1.2	£1.27	£2.39	£8.63	£23.10
	Ø 20 × 2	£1.92	£3.44	£15.22	£28.02
	Ø 30 × 2	£3.42	£5.04	£14.10	£45.07
	Ø 40 × 3	£6.98	£16.08	£28.61	£58.06
Box section 	50 × 50 × 3	£9.76	£15.74	£22.33	£72.41
	25 × 10 × 2		£5.04		
	40 × 20 × 2		£7.29	£18.76	£52.65
	50 × 25 × 2		£14.65	£22.60	£69.60
	50 × 100 × 3		£34.79		

Sheet metal (price per 1000 mm × 1000 mm sheet)						
	Size	Mild steel	Aluminium	Stainless steel	Brass	Copper
Sheets	1 mm thick	£17.17	£16.67	£75.05	£292.89	
	2 mm thick	£40.88	£38.73	£160.39	£238.40	£297.00
	3 mm thick	£51.10	£52.96	£240.55	£361.60	£440.00
	4 mm thick		£94.63		£598.46	
	6 mm thick	£84.05	£127.60			
Perforated sheet	6 mm hole, 8 mm pitch, 1 mm thick	£41.57				
	10 mm hole, 15 mm pitch, 3 mm thick	£75.62				
Tred plate	3 mm thick	£70.42	£66.06			

Plastic sections, granules and sheets

Plastic sections (price per linear metre)								
	Size	ABS	Acrylic	Polypropylene	Polystyrene	Polythene	PVC	Nylon
Round bar 	Ø 10		£3.78	£1.43		£0.73		£1.74
	Ø 20		£12.68	£5.32		£1.25		£6.62
	Ø 30		£28.00	£10.62		£4.00		£10.62
	Ø 40		£50.75	£18.98		£6.63		£25.52
	Ø 50		£93.35	£27.36		£26.53		£32.51
Square bar 	10 × 10		£4.18	£1.57				£1.91
	20 × 20		£13.98	£5.85				£7.24
	30 × 30		£30.80	£12.24				£11.68
	40 × 40		£55.75	£20.98				£28.02
	50 × 50							£35.75
Square tube 	10 × 10		£2.20				£0.95	
	20 × 20		£5.80				£1.07	
	30 × 30		£7.45				£1.32	
	40 × 40		£8.61				£1.68	
	50 × 50		£11.98				£2.07	
Round tube 	Ø 10	£0.69	£2.00				£0.42	
	Ø 20	£1.02	£5.20				£0.76	
	Ø 30	£1.69	£6.95				£2.07	
	Ø 40	£2.36	£8.00				£3.00	
	Ø 50	£3.03	£11.02				£4.73	
Angle 	25 × 25 × 2						£1.19	
	30 × 30 × 2						£1.59	
	40 × 40 × 2						£2.23	
	50 × 50 × 2						£3.02	
U channel 	25 × 25 × 2						£1.50	
	20 × 20 × 2						£1.29	
	15 × 15 × 2						£1.12	
	10 × 10 × 2						£0.84	

Plastic granules (price per kg)							
	ABS	Acrylic	Polypropylene	Polystyrene	Polythene	PVC	Nylon
Granules	£21.00	£24.00	£14.00	£18.00	£14.00	£12.00	£28.00

Plastic sheet materials (price per 1000 mm × 1000 mm sheet)						
	Size	Acrylic	Polypropylene	Polystyrene	PVC	Nylon
Sheets	1 mm		£11.56	£12.60	£11.52	£16.98
	4 mm	£40.60	£33.45	£34.16	£33.99	£68.09
	8 mm	£76.96	£66.91		£67.99	£94.74
	12 mm	£121.80	£100.37		£101.97	£207.10

Fixings

Threaded bar, nuts, bolts and washers					
	Length	M6	M8	M10	M12
Zinc plated threaded bar	1000 mm	£1.24	£1.73	£2.48	£3.71
Zinc plated nut (price per pack of 10)		£1.00	£1.90	£2.80	£3.80
Zinc plated washer (price per pack of 10)		£0.80	£1.00	£1.30	£1.50
Nut, bolt and washer (price per pack of 10)	20 mm	£1.16	£1.29	£1.49	£1.61
	30 mm	£1.47	£1.77	£1.98	£2.10
	40 mm	£2.79	£2.94	£3.21	£3.39
	50 mm				

Screws (price per pack of 10)					
	Length	Ø 3.5 mm	Ø 4 mm	Ø 5 mm	Ø 6 mm
CSK wood	20 mm	£0.20	£0.22		
	30 mm	£0.22	£0.24		
	40 mm	£0.22	£0.28		
	50 mm	£0.30	£0.35	£0.30	
	60 mm		£0.40	£0.60	
	70 mm		£0.55	£0.70	
	80 mm			£0.75	£1.29
	100 mm			£1.00	£1.60
Stainless steel self-tapping	12 mm	£0.40			
	25 mm	£0.50	£0.80	£1.00	

Pop rivets (price per pack of 10)			
Length	Ø 3.2 mm	Ø 4 mm	Ø 4.8 mm
8 mm	£0.16	£0.20	
12 mm		£0.34	£0.34
16 mm			£0.60
25 mm			£0.82

Published: June 2024

Change since last published:

Page 5: amends to Hand and head table